

# VALLEY TOWNSHIP

## WINTER 2019/2020 NEWSLETTER

Patrice L. Proctor, Chairwoman  
Kathy O'Doherty, Vice Chairwoman  
Christopher Lehenky, Member & Roadmaster  
Joe Sciandra, Member & Emergency Management Coordinator  
William H. Handy, Sr., Member

---

**Website: [www.valleytownship.org](http://www.valleytownship.org)**

---

890 West Lincoln Highway, PO Box 467, Coatesville, PA 19320

Phone: 610 384-5751 Fax: 610 384-2746

*Administrative Office Hours:*

Monday – Friday: 7:30 am – 4:30 pm

*Building/Zoning/Code Office Hours:*

Monday – Friday: 7:30 am – 3:30 pm

---

## WANTED

Valley Township is seeking any photos or maps of homes, buildings, people, events, etc., of historical interest within Valley Township. We would be happy to accept any as a donation or on loan to the Township in order to get reproduced. The new Township Building will have a large public gallery/reception area where we would like to showcase the history of Valley Township. These items are also very helpful when applying for grants and funding for certain projects.

Please contact Carol Lewis, Township Manager, if you have any items that you feel may be of interest (610 384-5751, ext. 16 or [manager@valleytownship.org](mailto:manager@valleytownship.org)).



## Township Logo

The Valley Township Board of Supervisors, after reviewing several drafts of possible logos, voted to approve the new logo for the Township shown to the right. Working with W. J. Strickler Signs on the design, the logo will be displayed on the new digital that will soon be operational at the site of the new Township Building at 1145 West Lincoln Highway, Coatesville. The quadrants of the logo represent the history of the textile industry, farming, aviation, and steelmaking in Valley Township.

## *Valley Township recognizes ....*



The Honorable Judge Grover Koon administered the Oath of Office to Tim Parker as Sergeant at the Valley Township's Board of Supervisor Meeting of August 6, 2019. Sergeant Parker started with Valley Township as a Part-Time Officer in May 2006 and was promoted to Full-Time Officer in February of 2009.

Sergeant Parker's parents and his wife Christina participate in the ceremony as his four children look on. Congratulations to Sergeant Parker on this promotion.

## *Valley Township welcomes ....*

The Honorable Judge Grover Koon administered the oath of office to **Jennifer Schreiber** at the Board of Supervisors' meeting of September 17, 2019, who joins the Valley Township Police Department as a part-time police officer. Officer Schreiber is also an Emergency Medical Technical Crew Chief for the Washington Hose Company No. 1 EMS.

Valley Township is pleased to announce that **Kate Kelly** and **Sharon Yates** were appointed as members to the **Environmental Advisory Council** and **Jennifer Kowaleski** was appointed as an Alternate.



The EAC participated at the recent Valley Day with hand outs and literature on topics such as recycling and stormwater. The EAC poster at their table was contributed by Lucy Thomas, age 6.

### **Township Administration**

Carol R. Lewis, Township Manager/Treasurer  
Brian A. Newhall, Chief of Police  
Janis A. Rambo, Township Secretary & Right to Know Officer  
Cynthia King, Assistant Secretary/Treasurer  
Janice A. Duca, Senior Clerk - Water/Sewer/Trash Billing  
Kelly Young, Assistant Clerk I – Water/Sewer/Trash Billing  
Kathy Jeffers, Building/Zoning/Code Secretary  
LTL Consultants, Building/Zoning/Code Officer  
Pennoni Associates Inc., Township Engineer  
Unruh, Turner, Burke & Frees, Township Solicitor  
Lamb McErlane, Zoning Hearing Board Solicitor

Christopher Lehenky, Roadmaster  
Kris Lenhart, Public Works Lead Worker I  
Brian Myers, Public Works Lead Worker II  
Chester County Treasurer, Real Estate Tax Collector  
Keystone Collections, Earned Income Tax Collector  
Joseph Sciandra, Emergency Management Coordinator  
Nichole Sciandra, Deputy Emergency Mgmt Coordinator

# Valley North Voting District Update

It was noted in the *Summer/Fall Township Newsletter* that, starting with the General Election in November 2019, the Valley North Voting District would be broken down into 3 voting districts. **Chester County Voter Services has notified us that this unfortunately will NOT begin in November 2019. It is anticipated this will start in the Primary Election of Spring 2020.**

**Valley North will have one voting location, Rainbow Elementary School, for the General Election on November 5, 2019 .**

No Change for Valley South Voting District.



**General Election Day  
Tuesday, November 5, 2019**

**North Precinct**  
Rainbow Elementary School  
1113 West Lincoln Highway

**South Precinct**  
Westwood Fire Company  
1403 Valley Road

---

## ***Planning Commission Vacancy:***

### **Valley Township Planning Commission:**

- Must be a Valley Township resident
- Planning Commission meets the second Tuesday of each month at 7:00 p.m.
- Current vacant term expires 12/31/22



*Deadline for submission is November 8, 2019*

Please forward a letter of interest noting any special qualifications to:

Valley Township  
Attention: Township Secretary  
PO Box 467, 890 West Lincoln Highway  
Coatesville, PA 19320

Or eMail to [jrambo@valleytownship.org](mailto:jrambo@valleytownship.org)

# *2020 Holiday Trash/Recycle Schedule for Valley Township*

<i>Holiday</i>	<i>Observed Holiday Date</i>	<i>Trash Collection</i>	<i>Recycle Collection</i>
New Year's Day	Wednesday, January 1	January 2	January 2
Martin Luther King Day	Monday, January 20	January 21	---
Presidents' Day	Monday, February 17	February 18	---
Memorial Day	Monday, May 25	May 26	---
Independence Day	Friday, July 3	July 6	July 6
Labor Day	Monday, September 7	September 8	---
Veterans' Day	Wednesday, November 11	November 12	November 12
Thanksgiving Day	Thursday, November 26	November 27	November 27
Day After Thanksgiving	Friday, November 27	November 27	November 30
Christmas	Friday, December 25	December 28	December 28
<i>Road crew will work Day After Thanksgiving Holiday (Friday, November 27); double-trash collection route &amp; Thursday's recycle will be collected; Friday's recycle collection will be collected on Monday, November 30</i>			

If your trash or recycle day falls on the "Observed Holiday Date" listed above, please refer to the chart for your collection date. Any questions, please contact the Township Office at 610 384-5751 to confirm your "make up" date.

## *2019 Leaf Collection*



November 4  
November 18  
November 25

December 2  
December 9



- Bags must be placed at curbside by 5:00 a.m. on the collection days. If your bags are not collected on the Monday collection date, leave bags at the curb for collection by the Public Works Department on Tuesday. We collect rain or shine.
- Leaves must be placed in bio-degradable paper collection bags. To avoid damaging the equipment used to compost the leaves, the bags must be free of plastic, trash, sticks and all other debris.
- Leaves placed in any other container, including trash and recyclable totes, will not be collected.
- Do not staple or tape yard waste bags closed.
- Bio-degradable bags may be purchased at the Township Building, 890 West Lincoln Highway, Coatesville, PA, during normal business hours of 7:30 a.m. to 4:30 p.m. at a cost of 5 bags for \$3.00. Residents may also use biodegradable bags sold at local stores.

## *Trash Container Regulation Reminder*

Residents have two options for trash containers:

- 32-gallon capacity cans, with lids and handles (weight cannot exceed 50 pounds)
- 48-gallon container which have all of the following:
  - Recessed metal rod which allows cart tipper to dump container
  - Must have lid
  - Must have wheels



Total amount of trash collected per household will remain at 128 gallons which will still allow four 32-gallon containers or up to two 48-gallon containers and one 32-gallon container.

# *Remaining 2019 Holiday Trash/Recycle Schedule for Valley Township*

<i>Holiday</i>	<i>Observed Holiday Date</i>	<i>Trash Collection</i>	<i>Recycle Collection</i>
Veterans' Day	Monday, November 11	November 12	---
Thanksgiving Day	Thursday, November 28	November 29	November 29
Day After Thanksgiving	Friday, November 29	November 29	December 2
Christmas	Wednesday, December 25	December 26	December 26
<i>Road crew will work Day After Thanksgiving Holiday (Friday, November 29); double -trash collection route &amp; Thursday's recycle will be collected; Friday's recycle collection will be collected on Monday, December 2</i>			

## *Recycle Reminders*

### **What NOT to Put in the Cart ..**

- No styrofoam, packing foam/peanuts
- No plastic “grocery store” bags
- No yard waste, dirt, grass clippings
- No light bulbs, drinking glasses, crystal, ceramic cups & plates and ovenware
- No mirrors
- No paint cans
- No oil cans or bottles
- No caps or lids
- No tissues, towels, napkins
- No food wrappers
- No wax or plastic coated boxes
- No tyvek plastic envelopes
- No metallic wrapping paper
- No building materials



### **Please note:**

**Our Recycle Center no longer accepts shredded paper and bound (soft and hard cover) books.**

### **What to Put in the Cart ...**

- Newspapers
- Mixed paper -- cardboard, paper bags, magazines, mail, home/office & school paper, egg cartons, clean pizza boxes, box board (cereal, cake and cracker boxes)
- Glass – rinse and remove lids
- Aluminum – beverage cans, pie plates & clean foil. Rinse!
- Metal – rinsed food & beverage cans, empty metal aerosol cans
- Plastic - #1 - #7

# Rainbow Valley Dental



Stephanie McGann, DMD

- Great Reviews
- Member ADA
- Convenient Office Hours
- Caring Staff
- Personalized care

[www.rainbowvalleydental.com](http://www.rainbowvalleydental.com)  
visit our website to learn more and  
take a virtual tour of the office.

## New Patients Welcome Dental Care for the Entire Family



610-383-4747

1208 West Lincoln Hwy

Across the street from ALDI



HOME | AUTO | BUSINESS

*Providing comprehensive, cost-effective  
and quality insurance solutions for  
families and businesses since 1949.*

1140 WEST LINCOLN HIGHWAY  
COATESVILLE, PA 19320

610-384-1980

[WWW.BINSURED.COM](http://WWW.BINSURED.COM)

*"Our clients feel  
like family."*

—CHIP BREUNINGER, PRINCIPAL  
& JOE REGENSKI, PRESIDENT



# FLING'S TOWING inc.



FAMILY OWNED AND OPERATED  
SINCE 1985

(610) 383-6362

[www.flingstowing.com](http://www.flingstowing.com) | Coatesville, PA



# *Invasive Species*

According to the United States Department of Agriculture (USDA) invasive species is defined as a species that is non-native (or alien) to the ecosystem under consideration and whose introduction causes or is likely to cause economic or environmental harm or harm to human health.

Introducing an invasive species to the environment can have such a devastating effect; several federal and state laws assist the government to work to stop the spread of invasive species. What makes invasive species so aggressive and difficult to control are their rapid growth, the ability to grow, survive and reproduce in many conditions and most notably, the lack of natural predators (think stinkbugs and spotted lantern flies); they can alter entire ecosystems!

Most people think of animals or pests when they envision an invasive species but plants can also be an issue as well. According to [dncr.pa.gov](http://dncr.pa.gov), invasive plants can include herbs, trees, shrubs, vines and even some grasses. Nuisance plants or noxious weeds are those

that can directly or indirectly cause problems for agriculture, natural resources, wildlife, recreation, navigation, public health or the environment according to the USDA. There are numerous federal, state and local resources available online for more information. Valley Township encourages its residents to prevent the spread of invasive species. You can do this by verifying that the plants you buy are not invasive; Many invasive species are sold by retailer such as Crown Vetch show below as a beautiful ground cover. Plant only native species in your yard or garden. Don't release plants or animals into the wild. Always clean your shoes and clothes and hiking and fishing gear before you hike or fish in a new area to prevent transfer of seeds or pests – make sure to check your pet's paws too!



## *Robinson Avenue & Oaklyn Lane to Become One-Way*

The Board of Supervisors, after more than a year of analyzing concerns with traffic on Robinson Avenue and Oaklyn Lane, voted to create the following directional paths:

- **Retain Robinson Avenue as a 2-way street between Airport Road and Oaklyn Lane;**
- **Establish a counterclockwise movement beginning with Robinson Avenue as one-way travelling west at the intersection of Oaklyn Lane;**
- **Establish Buckthorn Drive as one-way travelling south between Robinson Avenue and Oaklyn Lane; and**
- **Establish Oaklyn Lane as one-way traveling east.**



The Ordinance to adopt the traffic pattern change was approved at their public meeting of October 1, 2019. It is estimated that signage will be installed during the month of October and the traffic pattern will begin in November 2019. Letters will be sent to residents of Robinson Avenue, Oaklyn Lane, and Buckthorn Drive regarding the new pattern and the necessity to ensure mailboxes are on the correct side of the street for mail delivery. The Township has also been in communication with the School District transportation department to ensure a smooth transition.

## *Parks & Recreation Authority Volunteers Needed:*

Volunteers are needed to help with the various events of the Township to include: Easter Egg Hunt, Valley Day, Children's Holiday Party, Book-Bag-Giveaway, Annual Tree Lighting, etc. Parks & Recreation meets the fourth Tuesday evening at 7:00 p.m. at the Township Building. If interested, please submit a "Volunteer Form" which can be found on our website or attend an upcoming Parks & Recreation meeting!

# 2020 ALARM FEES

Please complete form (or download from our website) and return with the applicable fee to:  
In Person – 890 West Lincoln Highway, Coatesville, PA  
Mail – PO Box 467, Coatesville, PA 19320



---

## POLICE DEPARTMENT Valley Township

890 West Lincoln Highway - Coatesville - Pennsylvania - 19320  
www.valleytownship.org

610-383-7000

610-384-1796-FAX

---

### VALLEY TOWNSHIP SECURITY SYSTEM INSTALLATION AND RENEWAL APPLICATION

Check one:  New Alarm System - \$25 fee  Annual Permit Renewal - \$10 fee

Date: \_\_\_\_\_

Property Owner: \_\_\_\_\_

Property Address: \_\_\_\_\_

Owner Address (if different than above): \_\_\_\_\_

Owners Phone Numbers: \_\_\_\_\_, \_\_\_\_\_

Installation Date: \_\_\_\_\_

Alarm Type(s):  Fire  Security/Burglar  Audible  Silent

Is the alarm monitored by a Security Company?  Yes  No

Security Company and Phone Number: \_\_\_\_\_

Emergency Contact information (If owner is not available):

1) Name: \_\_\_\_\_ Phone # \_\_\_\_\_

2) Name: \_\_\_\_\_ Phone # \_\_\_\_\_

Additional Information:



# Solicitation Awareness:

Under the law, people and companies may offer their goods and services to the residents of Valley Township by way of solicitation. However, they do have rules they have to follow. If your property is marked with a sign that says "No Solicitation", they may not come onto your property to try and get your business. They also may not harass, threaten, or intimidate you.

The Township also requires solicitors to register and obtain a permit from the Police Department. If a solicitor has a permit like the one pictured, and it is not expired, they have met this requirement. If you don't see one, ask for it. If they don't have one, please call the police at 610-383-7000 so we can speak to them.

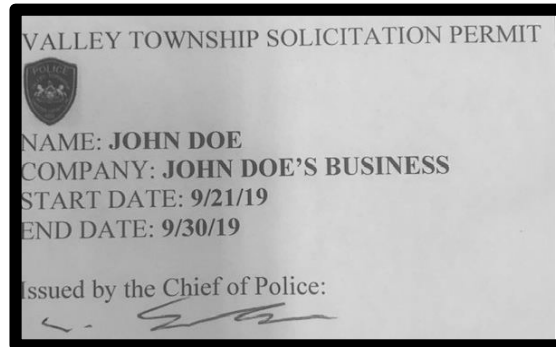

## MedReturn Drug Collection Unit

As part of a County-wide initiative, Valley Township was issued a MedReturn Drug Collection Box for residents to bring in prescription and over-the-counter medications that they no longer need. The collection box is located in the lobby at the Township Building



### Acceptable Items

- Prescriptions
- Prescription patches
- Prescription medications
- Prescription ointments
- Over-the-counter medications
- Vitamins
- Samples
- Medications for pets

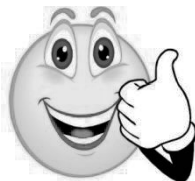

### NOT Accepted

- Hydrogen peroxide
- Inhalers
- Aerosol cans
- Ointments/lotions/liquids
- Medications from businesses or clinics
- Needles
- Thermometers



# Grant Awarded

## Concord Street Reconstruction –

Valley Township was awarded a Community Development Block Grant from the Chester County Department of Community Development in the amount of \$240,000. The project is located on Concord Street, in the central southern region of the Township, in the Township's West End neighborhood. The segments of roadway to be reconstructed consist of Concord Street from West 9<sup>th</sup> Street to West 10<sup>th</sup> Street and from West 10<sup>th</sup> Street to West 11<sup>th</sup> Street. The restoration and improvements on Concord Street include the complete reconstruction of approximately 1,250 linear feet of roadway as well as the installation of new stormwater management infrastructure. The western segment of Concord Street will be completely reconstructed, including a variable depth mill down to the existing stone or soil subbase. The road will be repaved to the Township's standard road section.

The existing grade of the road and surrounding properties generally drains to the southwest. Therefore, the western segment of the road reconstruction will be superelevated to the north in order to direct stormwater from the roadway and northern properties to the south side of the road, similar to its current condition. A standard PennDOT 8" concrete curb will be constructed along the south side of the road to convey stormwater to the west, out to W. 11th Street. The curb will run the full length of the west segment of Concord Street to W. 11th Street with a depressed section across an existing driveway on the south side of the road. Approximately 40 feet of existing damaged bituminous curb at the radii of the intersection of Concord Street and W. 11th Street will also be replaced with 8" concrete curb.



The eastern segment of Concord Street will be completely reconstructed in the same fashion as the western segment, with a variable depth mill and then repaved to the Township's standard section. The existing roadway grade is nearly flat across the length; however, a high point exists approximately 100 linear feet east of W. 10th Street, and a low point exists approximately 300 linear feet east of W. 10th Street. The existing road is generally sloped to the east and superelevated to the south. An existing failed culvert drains water along W. 10th Street across Concord Street. The reconstructed roadway will maintain and accentuate the high point and superelevation of the road, while also raising several low sections to eliminate the low point, and thereby preventing water pooling. Several residential driveways will also require adjustments to meet the altered road elevation.

Stormwater infrastructure is proposed for the eastern segment off Concord Street. Concrete curb is proposed along the entire north side of this segment in order to catch and convey stormwater. The existing, failed 12" corrugated metal pipe culvert at the intersection of Concord Street and W. 10th Street will be replaced with a 12" RCP Class IV pipe for its full length of approximately 40 linear feet in order to convey stormwater draining west from the road high point. East of the high point, the road and curb will be graded to maintain a positive slope to the east to convey stormwater. However, due to the generally flat grade of the existing road, it is not possible to raise the road sufficiently to maintain a minimum design slope for the entire length. Therefore, to achieve sufficient stormwater drainage, a trench drain is proposed along the north side of the road for the easternmost 350 linear feet of the roadway. The trench drain will cross to the south side of the roadway at the intersection with W. 9th Street and connect to a new 12" storm sewer pipe, which will run down the west side of W. 9th Street for approximately 100 linear feet before daylighting into an existing swale.

It is anticipated that the earliest the project would be completed would be late 2020 or more likely in 2021.

# *Hemlock Bridge Project Update*

It was previously announced in late 2018 that Valley Township was awarded a Community Development Block Grant from the Chester County Department of Community Development in the amount of \$348,000. The Hemlock Avenue Bridge had been posted for a 10-ton limit on the northern approach from Valley Road, most likely to restrict trucks from crossing the bridge. However, during inspections by the Township Engineer in April 2018, a reduced 3-ton posting for local traffic only was recommended. This 3-ton posting still allows residential vehicles to access this portion of the Westwood neighborhood. The bridge reconstruction will restore the bridge to its full load capacity to accommodate all vehicles. The proposed project involves the reconstruction of the Hemlock Avenue Bridge superstructure and the repair of scouring occurring in the substructure. The existing superstructure will be demolished and removed while maintaining the existing substructure. After the superstructure is demolished, the substructure will be retrofitted for the new superstructure which will then be installed. Once the superstructure is in place and the concrete has cured,

asphalt pavement will be installed. Additionally, this project includes the installation of rip-rap at a scoured area along the southwest wingwall and south abutment. Finally, this project includes other miscellaneous work, including installation of guiderails and erosion and sediment control.

The Department of Community Development's environmental project approval from HUD is anticipated in early November. The project can then proceed with bidding, award of contract, and construction to begin in the spring. It is anticipated that construction will take approximately 90 days with completion in Summer 2020.

Hemlock Avenue will close from Valley Road to Sheeler Lane for the duration of the construction.

## *Avoid Costly Clogs*

Unlike toilet paper, many hygiene products and wipes don't break down once they are flushed.

Wipes, even those that are labeled as flushable, can clog your sewer pipes and leave you with a nasty repair bill.

On a larger scale, when these products make their way into the public sewer system, they can collect together and cause blockages in the sewer mains, get tangled up in the pump equipment and result in service problems. So instead of flushing these items down the drain, throw them in the trash!



### What NOT to Flush or Pour Down the Drain

- Acids
- Baby wipes
- Cat litter
- Cigarette filters
- Condoms
- Diapers
- Facial tissues
- Food scraps
- Engine coolants (antifreeze)
- Gas or motor fuels
- Grease and fats
- Hair
- Herbicides
- Paint & paint thinners
- Paper
- Paper towels
- Pesticides
- Petroleum solvents
- Photographic development solutions
- Plastics
- Sanitary napkins
- Septic tank additives
- Tampons
- Textiles
- Toxic chemicals
- Varnishes
- Used motor oils
- Water softener backwash



# 2019 VALLEY DAY SPONSORS

## Platinum Sponsor

*Pennoni Associates Inc.*

## Gold Sponsors

*Arcelor Mittal*

*Chester County Area Airport Authority*

*Fling's Towing Inc.*

*High Real Estate Group*

*James J. Terry Funeral Home*

*JGM Fabrication Constructors*

*Krapf Bus Companies*

*Unruh Turner Burke & Frees Attorneys*

## Silver Sponsors

*Albert P. Abdala III*

*Breuninger Insurance*

*Coatesville Savings Bank*

*Elite MGA*

*Kimmel Bogrette Architecture*

*Kimmel, Lora & Associates*

*L.F. Lambert Spawn Co Inc.*

*LTL Consultants, Ltd.*

*Martin Brower*

*Mt. Zion Baptist Church*

*PA American Water*

*Patwell Pharmaceutical*

*Sly Tom's Enterprises LLC*

*Servpro of Kennett Square*

*The Gilbertson Group*

## Bronze Sponsors

*The Benecon Group, Inc.*

*Blessed Virgin Mary Catholic Church*

*Citadel Federal Credit Union*

*Hill International*

*Koenig Engineering Inc.*

*L4 Development, LLC*

*Pacer Industries Inc.*

*Portnoff Law Associates LTD*

*Rainbow Bru Thru*

*Rainbow Valley Dental*

*Stratix Systems*

*Snap Fitness Coatesville*

*Thomas Comitta Associates, Inc.*

*WalMart of Parkesburg*

*Witmer Public Safety Group Inc.*

## Contributors

*Mail N More*

## In Kind

*Oasis Market*

*Greg A. Vietri*

*DJ Ty Smith*

*Jim Mobile*

THANK YOU! THANK YOU! THANK YOU! THANK YOU!

# **2019 RAFFLE SPONSORS**

**Alan Jarvis, Esquire**

**All Star Images**

**April Pugh**

**Arty's Auto Service**

**Bakers of Buffington**

**BJ's**

**Caln Township (Ingleside Golf)**

**Channel 6/ABC**

**Chick-Fil-A**

**Coatesville Flower Shop**

**Domino's Pizza**

**Giant of Thorndale**

**Harry's, the Neighborhood Place**

**Hot Nails**

**Lincoln Diner**

**Philadelphia Rock Gym**

**Rainbow Valley Dental**

**Rocco & Anna's Ristorante**

**Russell's Dance & Baton Studio**

**Sly Tom's**

**The Bowling Palace**

**The Rose Group/Applebee's**

**Urban Air Adventure Park**

**Venice Pizza & Pasta**

**Wegman's of Downingtown**

**William H. Handy, Sr.**

**Zing Sushi**

# Valley Township Receives “Community Award”

TMACC’s (Transportation Management Association of Chester County) Community Award is given to a group who actively and willingly works to improve the quality of life for residents, employees or the community at large, including trails and access to mass transit.

Valley Township was nominated for this year’s award by ChescoBus.

“As a municipality Valley Township sees the value of the Link bus service, and has made a committed financial investment,” TMACC Executive Director Tim Phelp’s said at the June award presentation. “Having partners like Valley Township investing in their residents, and in public transportation helps make the Link Bus a success”.



The Coatesville Link bus service is a Monday through Saturday bus that travels from Brandywine Hospital to Parkesburg, connecting residents to shopping, entertainment, medical appointments, and school. Funding for the Link is provided through PennDOT’s ACT 89 Program, with matching funds provided by the Chester County Commissioners, and support from municipalities like Valley Township. The service is managed by TMACC and is the largest public transportation service in Chester County.

Valley Township has been a financial supporter for the last three years.

The award was accepted on behalf of the Township by Patrice Proctor, Chair of the Valley Township Board of Supervisors, and Kathy O’Doherty, Vice Chair.



# SLYTOM'S

**BEER - WINE - ADULT SLUSHIES**

LOCATED AT 1099 W. LINCOLN HIGHWAY - VALLEY TOWNSHIP  
*across from Domino's Pizza*

**THE ONLY PLACE IN VALLEY TOWNSHIP SELLING WINE-TO-GO!  
LOCALLY OWNED AND OPERATED!!**

**15 DELICIOUS SLUSHIE FLAVORS!!!**

**OPEN 7 DAYS-A-WEEK 10AM-10PM**



# Utility Bill Payments

Utility bills (Sewer, Trash, Water) are due every January, April, July and October. If you do not receive your bill by the 5<sup>th</sup> of these months, please contact our office. When paying in person, **please bring the entire bill with you if you would like a receipt.** We accept cash, personal check or money orders.

## If mailing a payment:

Please send your payment to:

Valley Township  
P.O. Box 467  
Coatesville, PA 19320



## If you pay online through your bank:

Please ask them to send your payment, with your account number, in a separate envelope addressed to:

Valley Township  
P.O. Box 467  
Coatesville, PA 19320

Valley Township will not be responsible for misdirected or late mail. No adjustments will be made if your bank mails your payment to the incorrect address or encloses it with other correspondence. ***Addressing your payment by mail to "890 West Lincoln Highway" may result in the post office returning your envelope. Also, for bank issued checks, the bank may take your funds out of your account prior to the discount or face value deadline; however, if the check is received after the discount or face value due date, we must go by the date received. Please ensure your check is signed!***

Please note, that payments left at the Township *after administration business hours*, are not the responsibility of the Township Police Department or any other Official. The Township cannot be responsible for payments which are unsecured until proper business hours (**Monday - Friday 7:30 a.m. to 4:30 p.m.**) and as such, **will not be responsible for lost or stolen payments left after those hours. We want to encourage you to be mindful of the identity theft crisis that is becoming one of the biggest crimes and hardships for individuals and avoid leaving payments unattended after hours – especially taped to the front door!!**

---

## Attention Valley Township Water Customers:



Water meters are read through a remote device attached to the outside of your home. This remote device must be clear of all obstructions and must provide a direct line-of-sight for drive-by and walk-by meter readings. It is the responsibility of the property owner to keep the area where the remote device is located clear of all vegetation or other obstacles.

**If you receive an estimated reading on your bill, please contact the Township as soon as possible to provide the meter reading and schedule an inspection of your meter to determine why we are not able to get the reading. This can help avoid any surprises when an actual reading is able to be obtained.**

# Message from the Police Chief



## **Scams currently being committed:**

There are several scams currently in progress that are targeting members of our community, especially the senior members of our community. These scammers will try to scare you or entice you into sending them money. Here are a few of the most common ones:

**Social Security Scam** – People will get a call where they will be told the following or hear a message stating the following: “We have been trying to contact you because your Social Security number has been suspected for fraudulent activities so once you get this message kindly call us back as soon as possible on the same number or press one to speak to our investigating officer”. They may also say that there is a warrant out for your arrest and provide a “warrant control number”.

- The Social Security Administration will never call you in regards to your account. People who get this call should not give out ANY information and just hang up.
- The Social Security Administration does not issue warrants or arrest people. Warrants are not handled over the phone. Again, don't give out any information, and hang up.

**Employment Scam** – People will get an email from a supposed friend of a friend offering them a job as a “Secret shopper” or a store evaluator. They will send a check, and then ask they you send back most of the money (minus a supposed small commission for you), or they will ask you to purchase gift cards and send them back or call in with the serial numbers for the cards.

- Legitimate agencies will not pay you and ask for money back.
- No business or government agency will ever ask you to pay them in gift cards or iTunes Cards. Do not respond to these offers.

**Property Scam** - Never agree to rent a property over Craig's List or any other website. Always use a real estate company or a property management company.

**Grandparent Scam** – People may get a call from someone stating that “This is your favorite grandson/granddaughter” and that they have run into some legal trouble and are in need of bail money. They may ask for funds to be wired via Western Union.

- Law Enforcement does not accept wire transfers. Courts and jails accept cash, and sometimes credit cards or checks. NEVER give out your credit card information over the phone to someone you don't know.
- If someone asks for money, always ask their name.
- If someone says that they are in custody, ask to speak to a Law Enforcement Officer. Get a call back number. Hang up. Look up the supposed law enforcement agency on the internet. Only call them back if you can verify that they exist and that the number is correct.

## **Things to remember:**

- Scammers sound very convincing. Don't fall for it!
- No one accepts iTunes cards or gift cards as payment.
- NEVER give out your Social Security number, date of birth, account numbers, or other identifying information unless you know who it is you are talking to and it is absolutely required.
- Most of these scams originate overseas, and are very hard for Law Enforcement to investigate or prosecute. The best thing you can do is to not fall for them.
- The Valley Township Police Department is here to answer any questions you might have about potential scams. Feel free to call us at 610-383-7000.

*Chief Brian A. Newhall, M.S.*



### Bus Stop Parking Safety

Valley Township police officers are on the lookout for parents who park illegally at school bus stops in the Township. An officer recently observed an individual parking dangerously close to an intersection while waiting for a school bus to arrive. Contributing to the safety problem are limited visibility and a tight turning radius which are created by illegally parked vehicles. These hazards could cause a problem for vehicles that are approaching stop signs and/or intersections.

To help keep the bus stops in Valley Township as safe as possible, the police department is releasing a reminder for parents to keep a safe distance from intersections while parked at school bus stops. According to Pennsylvania vehicle law, a person may not stand or park a vehicle within 30 feet on the approach to any flashing signal, stop sign, yield sign, or traffic control signal located at the side of a roadway. Violators could be cited.

Valley Township officers will continue to patrol the school bus stops in the area in an effort to limit risks to children.

**1 Two-lane roadway:**  
When school bus stops for passengers, all traffic from both directions must stop!

**2 Two-lane roadway with a center turning lane:**  
When school bus stops for passengers, all traffic from both directions must stop!

**3 Four-lane roadway without a median separation:**  
When school bus stops for passengers, all traffic from both directions must stop!

**4 Divided highway of four lanes or more with a median separation:**  
When school bus stops for passengers, only traffic following the bus must stop.

### Do You Really Know How Deep the Water is?

12 inches of fast-moving water can carry away a small car.

18-24 inches of fast-moving water can carry away most large SUVs, vans and trucks.

6 inches of fast-moving water can knock over and carry away an adult.

**WHEN FLOODED TURN AROUND DON'T DROWN**

# Police: Don't give out too much information on bumper stickers

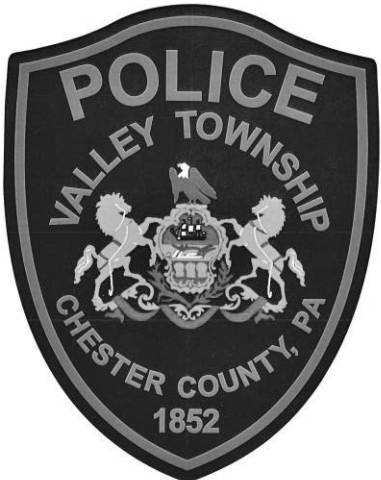

# Mattress/Box Spring Collection

Mattresses and box springs are no longer permitted to be dumped in the landfill. Valley Township will pick up these items for a fee of \$33.00 per item. This fee includes a mattress/box spring bag that will be provided upon payment to put your mattress or box spring in for collection. Collection of these items will be once per month on the last Monday of each month. The bags are required to protect Township Public Works personnel from any potential contact with bed bugs.



Payment must be made to Valley Township **one week prior** to the collection date. Mattresses and/or box springs should be set out by 5:00 a.m. on the day of collection and must be in the bag issued by the Township. To arrange a mattress and/or box spring collection, please contact the township office to arrange or for additional information. A collection form is available at the Township Office, on the Township website, or by completing the following information and returning/mailing it with your check (\$33 for each mattress and \$33 for each box spring) to the Township Office prior to the monthly collection date.

Dumping or accumulation on public streets or property and dumping or accumulation on private property is in violation of the Township Ordinances. Violators shall be guilty of a summary offense punishable by a fine not to exceed \$1,000, together with all court costs and reasonable attorney's fees incurred by the Township.



Name: \_\_\_\_\_

Address (collection address): \_\_\_\_\_

Number of mattresses: \_\_\_\_\_ Box springs \_\_\_\_\_

Amount paid: \_\_\_\_\_

Collection date: \_\_\_\_\_

---

## CRT Television & Monitor Collection

CRT televisions and monitors are no longer permitted to be dumped in the landfill. Valley Township will pick up these items for a fee as noted below. Collection will be once per month on the **last Monday of each month**. *Please note, we cannot collect console-type CRT televisions.*

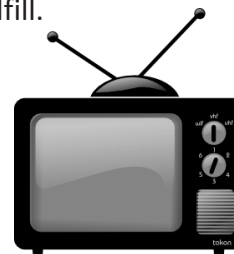

**TVs: 29" and smaller - \$25.00 / 30" and larger - \$45.00**

**CRT Monitors: 18" and smaller - \$25.00 / 19" and larger - \$45.00**

Payment must be made to Valley Township prior to 12:00 p.m. on the Friday prior to the collection date. Televisions should be set out by 5:00 am on the day of collection.

*Reminder: Flat Screen televisions are still accepted at the Township Building as part of their eWaste collection.*



Name: \_\_\_\_\_

Address (collection address): \_\_\_\_\_

Number of CRT televisions 29" and smaller: \_\_\_\_\_ CRT Monitors 18" and smaller: \_\_\_\_\_

Number of CRT televisions 30" and larger: \_\_\_\_\_ CRT Monitors 19" and larger: \_\_\_\_\_

Amount paid: \_\_\_\_\_ Collection date: \_\_\_\_\_

# Winter Events

December 8 – **Annual Tree Lighting** – 6:00 p.m.

*check website closer to event for more details*



December 14 – **Children's Holiday Party** – 12:00 p.m. – 2:00 p.m.

held at Rainbow Elementary School

*Additional information, as available, will be posted on the Township website, [www.valleytownship.org](http://www.valleytownship.org), included in future mailings, or can be obtained by contacting the Township Office*

*Tickets for the Children's Party will be available at the Township Office on Monday, November 25 during normal business hours.*

## Discount Movie Tickets Available For Sale



Tickets may be purchased by residents and non-residents at the Valley Township Municipal Office, 890 West Lincoln Highway, during normal business hours of 7:30 a.m. – 4:30 p.m. Tickets are for unrestricted access to any movie at any Regal, United Artist or Edwards theatres (except in Manhattan, NY) such as the Downtown Cinema Stadium. Not valid for special events or private screenings. *Surcharge fees apply at the theatre for all 3D, IMAX, large format, RPX and Real D films. Theatres may charge an upcharge at their discretion for stadium seat upgrade.*

**\$9.50 each**

*Cash Sale Only; sorry, no checks or credit cards.*

*Proceeds Benefit the*

*Valley Township Parks & Recreation Authority*



**CHANGE YOUR CLOCK  
CHANGE YOUR  
BATTERY**

Drs. Hochberg & Babilonia  
(610) 380-8401

name \_\_\_\_\_  
date \_\_\_\_\_  
time \_\_\_\_\_

Jody Hochberg, DDS  
Monica Babilonia, DDS  
1246 West Lincoln Hwy  
Coatesville, PA 19320  
**(610) 380-8401**

## SMEDLEY ORTHODONTICS, LTD

Board Certified Invisalign Certified  
We offer traditional braces along with Invisalign.

Most insurances accepted.  
(flexible payment plans)

3 Convenient Locations:  
Downtown; (610) 269-6065  
West Chester: (610) 431-1650  
Coatesville: (610) 380-9068

Call today for a free consultation!



Dr. Larry Smedley, Dr. Chris Smedley & Dr. Kendra Adey

# Tips for Safe Use of Portable Generators

During long-term power outages many rely on portable generators for emergency power ... but many generators are installed and operated incorrectly and pose a real threat to the lives of family, neighbors and utility crews working to restore service. Follow the tips below when installing and operating portable generators:

- **Follow the directions supplied with the generator.** Incorrect generator use can lead to carbon monoxide (CO) poisoning from the toxic engine exhaust, electric shock, electrocution and fire. Never use a portable generator indoors and never use a portable generator in a garage, carport, basement, crawl space or other enclosed or partially-enclosed area ... even with ventilation. Opening doors and windows or using fans will not prevent CO buildup in a home.
- **Generators should be at least 20 feet away from buildings.** At even 20 feet away air flow patterns may still blow carbon monoxide into homes through attic vents, windows or doors. Keep the generator away from these openings and maintain a working carbon monoxide detector inside the home.
- **To avoid electrocution, keep the generator dry.** Do not use in rain or wet conditions. Operate it on a dry surface under an open canopy-like structure. Make sure your hands are dry before touching the generator.
- **Turn off all appliances and lights before you begin operating the generator.** Once the generator is running, turn appliances and lights on one at a time to avoid overloading the unit. And don't forget to use safety-tested, shop-type electrical cords designed and rated for heavier, outdoor use.
- **Never try to power house wiring by plugging the generator into a wall outlet.** This practice, known as "back feeding" can lead to the electrocution of utility workers or neighbors served by the same utility transformer. The only safe way to connect a generator to house wiring is to have a qualified electrician install a power transfer switch.
- **Shut down your generator correctly.** Turn off and unplug all appliances and equipment being powered before shutting off the generator. Drain the gasoline from the generator while it is being stored and inspect the fuel and oil filters, spark plug, oil level and fuel quality on a regular basis .. And before the next power outage!

**For more info on portable generators, contact John Haynes, Emergency Operations Center Director, Chester County Department of Emergency Services, at (610) 344-5005.**



## What precautions should I take to prevent damage to pipes during freezing temperatures?

Make sure that the pipe coming into your home is not exposed to the elements. Most pipes are located underground. Once in your home, be sure the pipes are protected from any extreme temperatures at the point of entry. You can place insulation around or between where the pipe enters your home and the outside surface.



# Proper Placement of Mailboxes

## Help Reduce the Opportunity for Damage



Valley Township takes every precaution to avoid damaging mailboxes during snow removal operations. Below find some mailbox placement tips to help reduce the chances that your mailbox is damaged this winter:

- Along curbed roadways, set the mailbox back 2 feet from the edge of pavement to provide the maximum permitted roadway clearance.
- Along curbed roadways, set the back of the mailbox back 8 inches from the curb face.
- Install the mailbox on the side of your driveway away from approaching traffic. This will lessen the likelihood of a plow strike and minimize the shoveling needed to clear the area around the mailbox.

The Township will replace a standard mailbox and post only if either or both are struck by the plow and if these are installed to the specifications of the US Postal Service (USPS). The USPS requires that:

- Mailboxes must be installed at least 42" above the roadway surface; and
- Mailbox posts not exceed 4" by 4" for wooden posts, and a 2" diameter for steel pipe posts (larger posts deemed "deadly fixed objects", and are not permitted within the roadway right-of-way).

The Township neither replaces nor reimburses residents for custom mailboxes or ornate posts and the Township is not responsible for damage caused by snow or ice that is thrown from the snowplow blade.

If you believe a properly-installed mailbox or post was struck by a Township vehicle, please contact the Township at 610 384-5751.

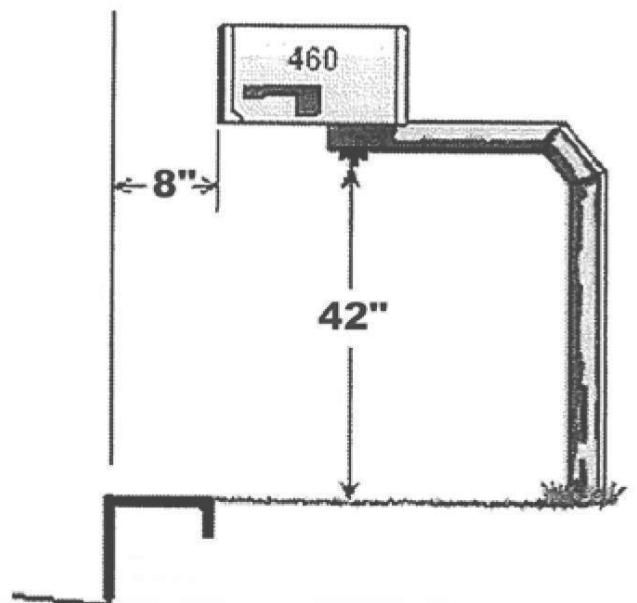

# Winter Weather

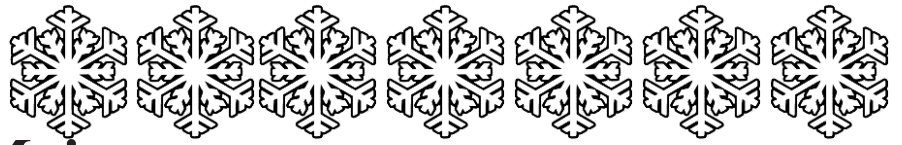

## & Winter Property Maintenance

Cooperation of residents is needed and appreciated for efficient snow removal efforts. Our goal is to provide exceptional service in maintaining clear, safe roads for our residents and passing motorists. Also, if you have a fire hydrant on your property, it is your responsibility that the hydrant is clear of snow. As always, our Public Works personnel will do their very best to keep roadways as clear as possible, but we need your help! When the first snowflakes begin to fall, please remember to:



- **Remove vehicles from the roadway until the roadway is cleared.** Vehicles parked on emergency routes may be towed.
- **Wait until the roadway is cleared before shoveling your driveway, sidewalk and mailbox area. But if you must clear these areas sooner, please know Township trucks will likely throw snow back onto your property when plowing the road.**
- Refrain from shoveling snow into the roadway. Pushing snow from your driveway or sidewalk into the roadway creates a safety hazard and could cause an accident, and is against the law. Property owners may be held responsible for accident damages.
- Prepare your vehicle for winter driving. If you are too nervous about driving on snow and/or ice, don't drive! Share a ride with a neighbor, or wait until the roadways are cleared before traveling.

Please note that the Township does not plow private roadways, roadways not dedicated to the Township and state-owned roadways.

The National Property Maintenance Code requires that you keep all walkways, sidewalks, driveways and stairs clear of hazardous conditions. You are required to remove snow and ice from these areas within 24 hours. Emergency personnel may not be able to reach you if there is an emergency at your home.

### Snow Shoveling Tips

PennDOT offers tips on shoveling your driveway to avoid being plowed in.

After a snowstorm, how many times have you shoveled your driveway only to have it plowed in?

PennDOT suggests that you clear an area to the right of your driveway (as seen in the diagram below) to give the snow on the blade of the plow a place to empty before it gets to your driveway. This way you won't have to do the same job twice.

PennDOT also reminds you that it is illegal to push snow from a parking lot or driveway onto a state highway.

Sketch shows the proper way to shovel snow out of your driveway.

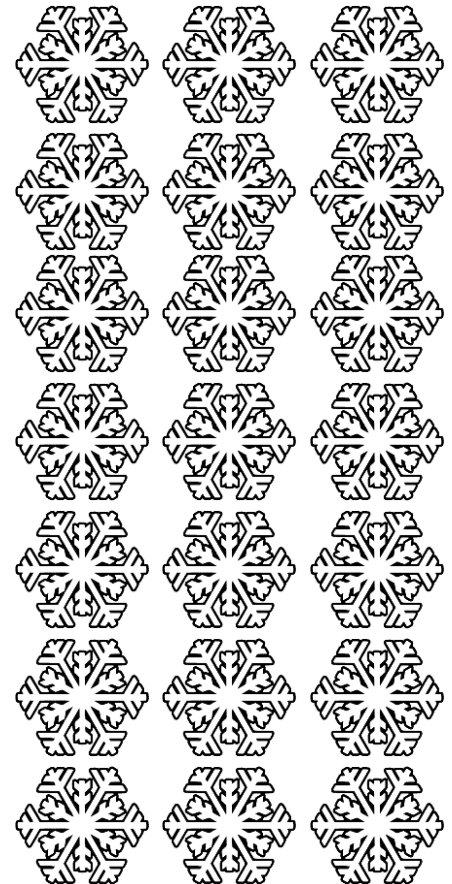

# Snow & Ice Emergency Declaration

Valley Township Ordinance 2008-13 allows for a declaration prohibiting the operation of motor vehicles after the Declaration of a snow and/or ice emergency, establishing snow emergency routes, prohibiting certain activities during a snow event, including the parking of vehicles on township roads and the removal of snow and/or ice from private property on to the township roads or streets, mandating the removal of snow and/or ice from fire hydrants by property owners and establishing penalties for violations of the ordinance.

After any snow emergency is declared, it shall be unlawful, at any time during the continuance of the snow emergency for any person to drive or park any motor vehicle of any such snow emergency routes, unless that vehicle is equipped with four-wheel drive or uses PennDOT approved snow chains.

After the Snow Event has been declared, **it shall be unlawful to park on any street or road which is part of the Township system after the start of a snow fall and until the snow has stopped falling and the snow has been completely plowed for the full width of the cart way.**

Any member of the Valley Township Police Department, or any employee of Valley Township engaged in road work, is authorized to remove any vehicle abandoned or parking upon any public highway or street in violation.

It shall be unlawful to dump, throw, shovel, pile or push any snow or ice removed from driveways or walkways into any public highway or street.

Fire hydrants shall not be covered. Property owners are required to remove all snow, ice, slush, etc., around the fire hydrants located on their property to provide access by fire rescue personnel.

A complete copy of Ordinance 2008-13 is available on the Township's website or for review at the Township Municipal Building.

## Snow Emergency Routes

Street	Between
Valley Road	Coatesville City & Sadsbury Twp Line
Mount Carmel Road	E. Fallowfield Twp Line & Valley Road
Park Avenue	E. Fallowfield Twp Line & Valley Road
Lincoln Highway	Coatesville City & Sadsbury Twp Line
Airport Road	W. Caln Twp Line & Lincoln Highway
Country Club Road	W. Caln Twp Line & Lincoln Highway
Glencrest Road	Irish Lane & Lincoln Highway
Irish Lane	Glencrest Road & Wagontown Road
Wagontown Road	W. Caln Twp Line & Coatesville City
Mineral Springs Road	Country Club Rd. & Wagontown Rd.
Pine Valley Drive	Country Club Rd. & Baltusrol Drive
Pleasant Valley Drive	Baltusrol Drive & Harry Road
Harry Road	Pleasant Valley Drive & Glencrest Road
Mount Airy Road	W. Caln Twp Line & end of roadway
Washington Lane	Lincoln Highway & Sadsbury Twp Line
Cynthia Road	Old Wilmington Road & Valley Road
Danielle Lane	Old Wilmington Road & Marc Drive
Marc Drive	Cynthia Rd(South) & Cynthia Rd (North)
Maple Avenue	Valley Road & Mt. Carmel Road
Ridge Avenue	Valley Road & Spruce Street
Spruce Street	Ridge Avenue & W. Birch Street
W. Birch Street	Sheeler Lane & Kirby Street
Kirby Street	Oak Avenue & Park Avenue
Euclid Avenue	Park Avenue & W. 12 <sup>th</sup> Avenue
Charles Street	W. 9 <sup>th</sup> Avenue & W. 11 <sup>th</sup> Avenue
W. 11 <sup>th</sup> Avenue	Charles Street & Valley Road
W. Main Street	Lincoln Highway & Rainbow Road
Highland Avenue	George Street & Front Street
Front Street	Highland Avenue & Rainbow Road
Rainbow Road	Lincoln Highway & W. Main Street
East Glencrest Road	Glencrest Road & Wagontown Road
Franklin Street	Glencrest Road & Country Club Road
Leeward Street	Franklin St (East) & Franklin St (West)
W. 3 <sup>rd</sup> Avenue	Leeward Street & W. Chestnut Street
W. Chestnut Street	W. 3 <sup>rd</sup> Avenue & 1 <sup>st</sup> Avenue
1 <sup>st</sup> Avenue	W. Chestnut Street & Lincoln Highway
Lamberts Lane	Country Club Road & Matthew Drive
Matthew Drive	Lamberts Lane & Mineral Springs Road
Pinckney Drive	Mineral Springs Road & Thomas Circle
Cambridge Way	Beacon Street & Mineral Springs Road
Beacon Street	Pinckney Drive & Thomas Circle
Mt. Airy Road	Wagontown Road & north end of road
Manor Road	Wagontown Road & PA Route 82
W. Kings Highway	W. Caln Twp Line & Caln Twp Line
PA Route 82	W. Caln Twp Line & City of Coatesville
Butterworth Road	PA Route 82 & Heston Road
Heston Road	Butterworth Road & Blackhorse Hill Road
Gilmer Road	Heston Road & end of roadway

## Are You Registered? .....



Stay Informed

[www.ReadyChesCo.org](http://www.ReadyChesCo.org)

Select Alerts for Public "Valley"

**VALLEY TOWNSHIP**  
**PO BOX 467**  
**COATESVILLE, PA 19320**

First Class Mail  
U.S. Postage  
**PAID**  
Permit #310  
19464

**Christmas Tree Collection Dates:**

**January 6, 2020**

**January 20, 2020**

**January 27, 2020**

(Set out by 5 a.m.)



**Board of Supervisors**

1<sup>st</sup> & 3<sup>rd</sup> Tuesday

7:30 pm – exceptions:

1<sup>st</sup> mtg in November – November 6

Reorg Meeting – January 6, 2020

**Planning Commission**

2<sup>nd</sup> Tuesday

7:00 pm

**Environmental Advisory Council**

3<sup>rd</sup> Thursday

6:30 pm

**Parks & Recreation Authority**

4<sup>th</sup> Tuesday

7:00 pm

**Town Watch**

Last Wednesday

6:00 pm

## Tax Information

Chester County Treasurer	610 344-6370
<i>Township real estate taxes</i>	
Keystone Collections Group	610 269-4402
<i>Earned Income tax - Township &amp; CASD</i>	
Berkheimer Associates	1-800-360-8989
<i>Coatesville Area School District real estate taxes</i>	
Chester County Treasurer	610 344-6370
<i>County real estate taxes</i>	

## Important Telephone Numbers

Township Police	610 383-7000 (Non-Emergency Calls)
Westwood Fire Company	610 383-0538 (Non-Emergency Calls)
Westwood EMS Office	610 383-1453 (Non-Emergency Calls)
Chester County Information	610 344-6000
District Court 15-1-05 (Judge Koon)	610 380-3325
Animal Control	Contact SPCA – 610 692-6113
Emergency	911